

パネルキャスターゲート H=3000 タイプ (PCGN)

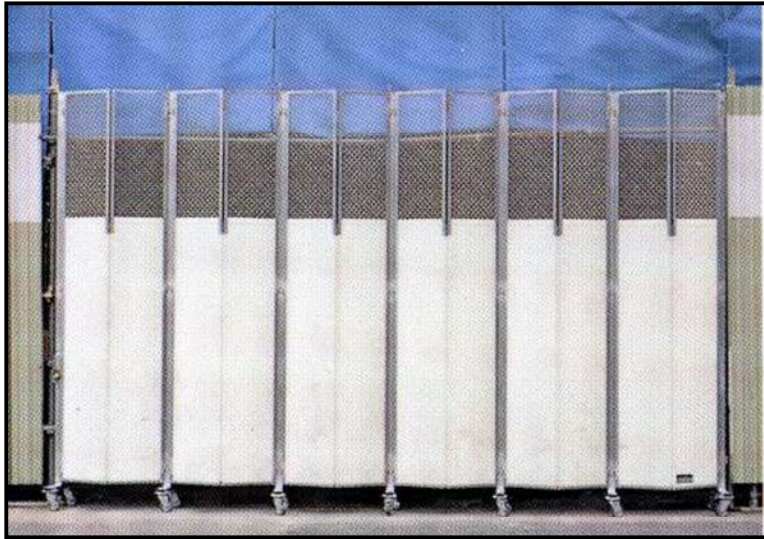

パネルキャスターゲート H=3m (PCGN)

	単管柱内々寸法	単管柱芯々寸法	有効開口寸法	パネル上部～G L	重量
PCGN-27	2,700mm	2,750mm	2,250mm	3,220mm	120kg
PCGN-36	3,600mm	3,650mm	3,050mm	〃	160kg
PCGN-45	4,500mm	4,550mm	3,850mm	〃	200kg
PCGN-54	5,400mm	5,450mm	4,650mm	〃	240kg
PCGN-63	6,300mm	6,350mm	5,450mm	〃	280kg

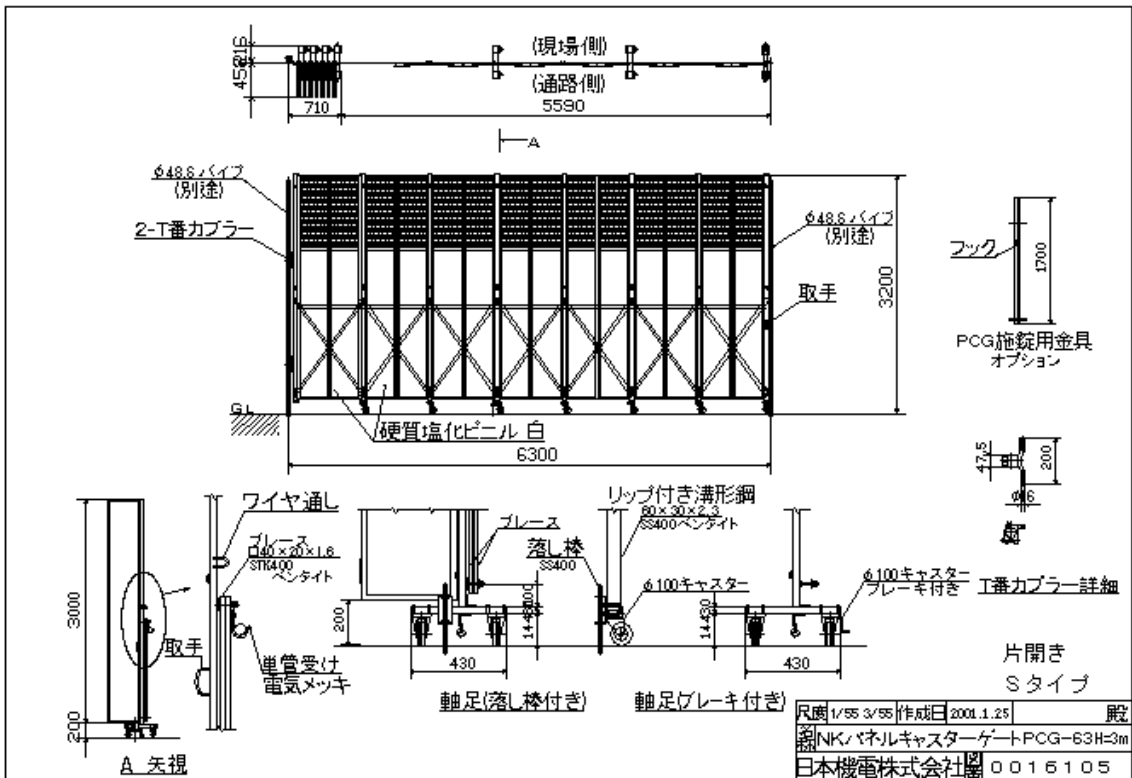

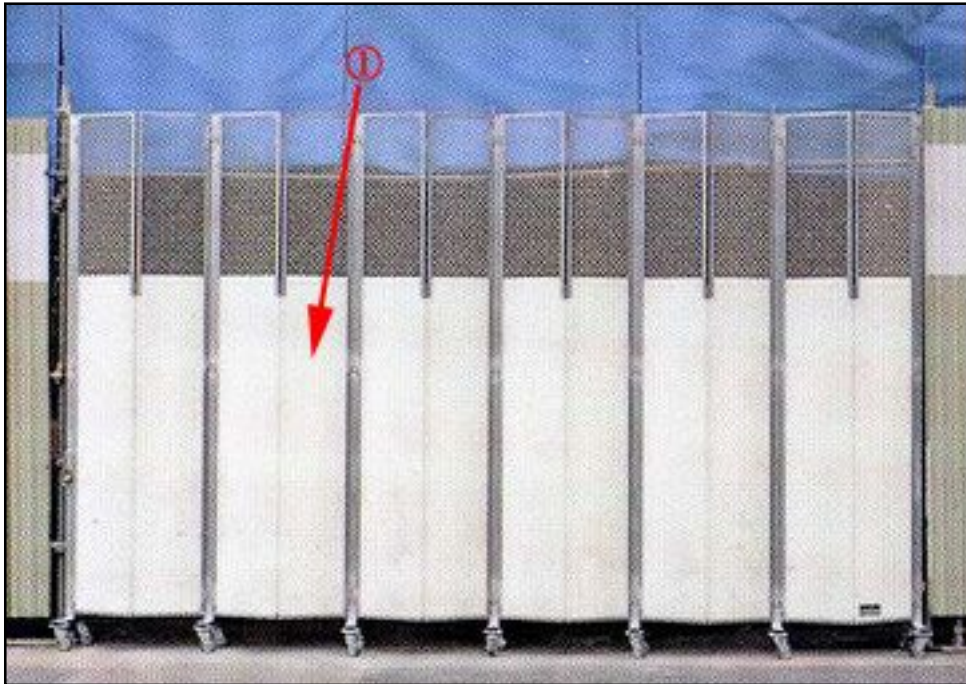



	①パネル	②骨組
PCGN-2 7	3	1
PCGN-3 6	4	1
PCGN-4 5	5	1
PCGN-5 4	6	1
PCGN-6 3	7	1



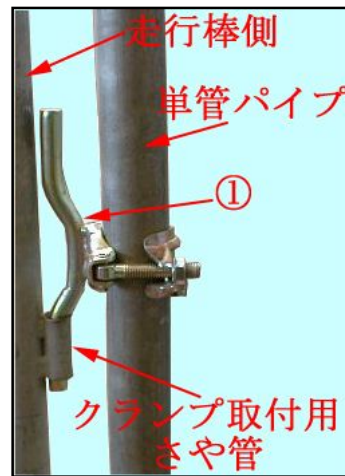
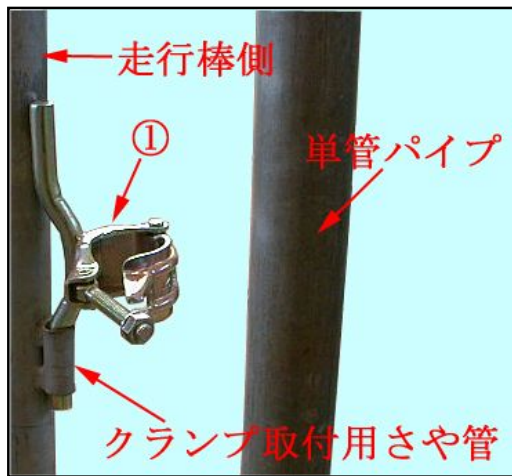

	①蝶番クランプ
全サイズ同数	2
	

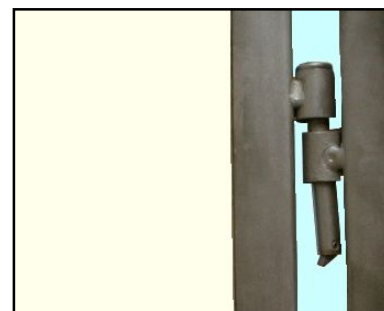
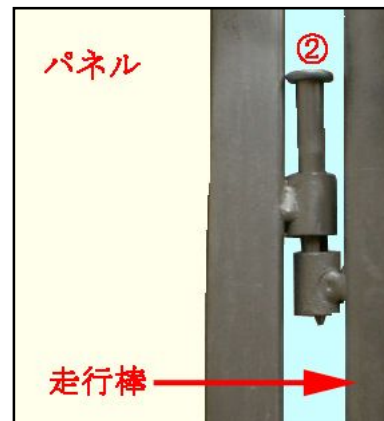

	②パネル止メピン
PCGN- 2 7	18
PCGN- 3 6	24
PCGN- 4 5	30
PCGN- 5 4	36
PCGN- 6 3	42
	

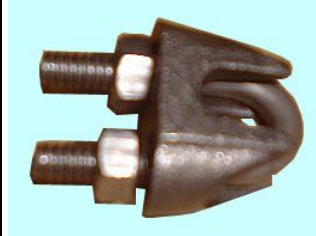

	①ワイヤー 8φ	②ワイヤークリップ	③ターンバックル
PCGN-2 7	4m×2	8	2
PCGN-3 6	5m×2	8	2
PCGN-4 5	6m×2	8	2
PCGN-5 4	7m×2	8	2
PCGN-6 3	8m×2	8	2
			

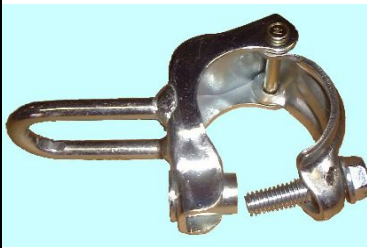
	④M4 クランプ
全サイズ同数	4
	

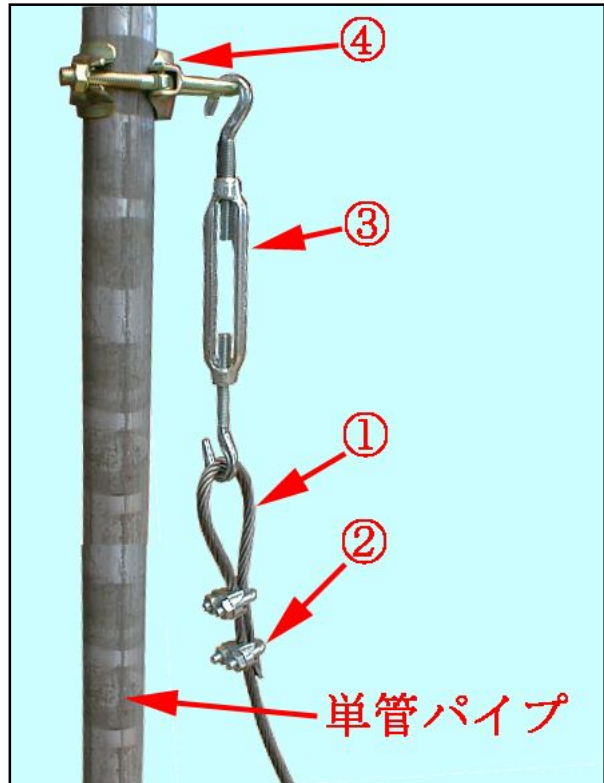

ゲート中央側

ゲート取付側

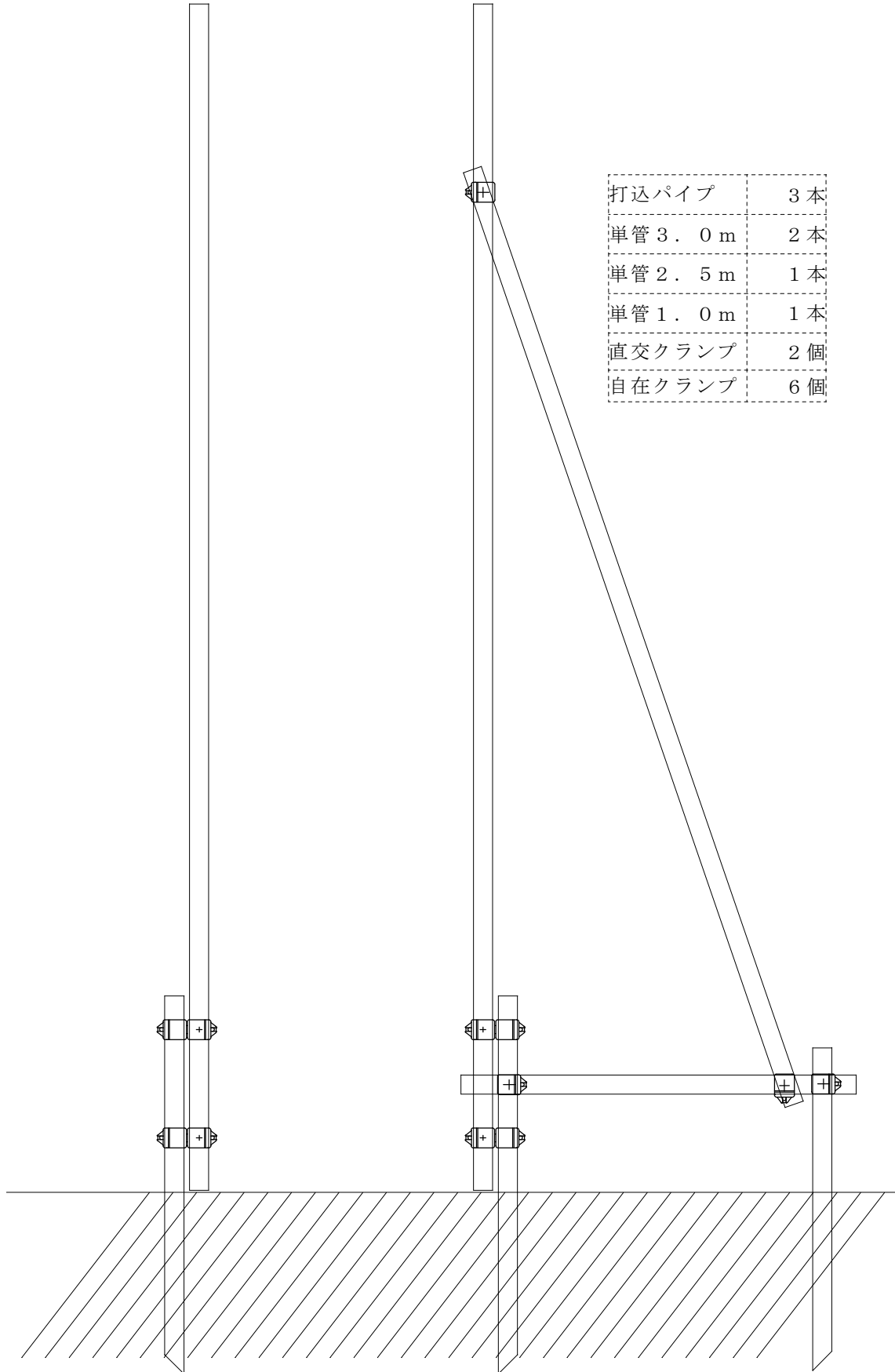

【 P C G N 取付用 単管組立図 】